

# CableMaster 500

Voice, Data & Video Tester with Length Measurement

- Tests Voice (6 wire), Data (8 wire) and Video (coax)
- Easy to read, extra large 7-segment LCD screen with large icons
- Tone generation over voice, data and video cables, with 4 different tones
- Measures length of entire cable and individual wire pairs
- Flashes the Port LED to visually identify the connected ports on a switch or router
- RJ (Voice & Data) master remote stores in bottom of case
- Maps 24 different locations at one time
- Tests and indicates pins with shorts, opens, reversals, miswires and split pairs
- Displays "Pass" icon for correctly wired T568A/B and crossover/uplink
- Displays "Pass" icon for correctly wired 6-pin telephone plus "Rev" for reverse-pinned
- Low power consumption for long battery life
- Auto power-off



## USER MANUAL

# CableMaster 500

## TABLE OF CONTENTS

<b>Overview</b> .....	<b>3</b>
<b>CableMaster 500 Features</b> .....	<b>3</b>
Safety Information .....	4
<b>CableMaster 500 Parts</b> .....	<b>5</b>
Screen Icons .....	6
<b>Test Results and Other Functions</b> .....	<b>8</b>
Using the Tester .....	10
<b>Cable Testing</b> .....	<b>12</b>
<b>Remotes</b> .....	<b>13</b>
<b>Interpreting Test Results</b> .....	<b>14</b>
Video (Coax) Cables.....	15
Voice (POTS) Cables.....	15
<b>Set Up Menus</b> .....	<b>16</b>
Setting the Cable Capacitance .....	18
Pass/Fail Settings .....	18
Single-Ended Testing .....	18
Port Link Light .....	19
Continuous Loop Testing .....	19
Backlight and Built-in LED Flashlight .....	19
Tone Mode .....	20
<b>Specifications</b> .....	<b>21</b>
<b>Warranty</b> .....	<b>22</b>

## Overview

The CableMaster 500 is designed to test and measure lengths of all common low voltage cabling found in today's network, video or telephone systems. It also maps the locations of cable ends by sending a tone on the cable that can be traced with a tone tracer or by blinking the LED on the port jack. The CableMaster 500 has a large, bright backlit LCD display and glow-in-the-dark buttons to directly access each function. The remote stores inside the main unit for ease of cable testing.

The CableMaster 500 is turned on by pressing the power button and begins operating in the last mode used or the selected mode twisted pair (DATA), coax (VIDEO), telephone (VOICE), tone generation (TONE) or Port Link-Blink (LINC).

## CableMaster 500 Features

### Cable Verification

- Test, measure, and map data, coaxial video and voice cables
- Fault testing for opens, shorts, mis-wires, reverses and split pairs
- Highly accurate length, opens and split detection using capacitive technology
- Port Link-Blink to visually identify connected ports on a switch or router
- Verify end-to-end grounding of shielded data cables
- Single-ended testing for shorts
- Wiremap testing to EIA T568A/B standards and cross-over cables
- Loop mode for continuous testing
- Recognizes up to 24 unique remote numbers for mapping cables
- Built-in 4-cadence tone generator for audible tracing of cable runs
- Auto-off and low power consumption for extended battery life

### Conveniences

- Built-in LED flashlight
- Easy-to-read large backlit LCD display
- Glow-in-the-dark buttons
- Audible Beep for additional feedback
- Ergonomic slip-resistant side grips
- Self-stored Master Remote – Squeeze remote at finger grip openings in main unit to remove
- RJ45, RJ12 and F-Jack on main unit and remote

# CableMaster 500

## SAFETY INFORMATION

To ensure safe operation of the CableMaster, follow the instructions carefully.

**WARNING! Do not attach to AC power.**

The CableMaster 500 is designed for use on **unenergized cabling systems.**

Connecting the CableMaster 500 to live AC power may damage it and pose a safety hazard for the user.

Failure to observe these warnings can result in severe injury or death.

### Always Check Connectors First!

Poorly terminated RJ45 connectors have the potential to damage the jacks on the CableMaster 500. Always visually inspect an RJ45 connector before inserting it into the tester. All the contacts should always be recessed into the plastic housing of the connector.

The use of a Port Saver, a sacrificial adapter with an RJ45 on one end and an RJ45 jack on the other, is highly recommended to extend the life of the jack.

Only insert RJ45 connectors into the RJ45 jack in the tester. Plugging 6-position connectors (RJ12/RJ11) into the 8-position jack on the tester may damage the outermost contacts of the jack unless the connector is specifically designed for that purpose.

















## CableMaster 500 Parts



1. Connector ports and built-in LED flashlight (top of tester)
2. Large Backlit LCD Screen
3. Glow-in-the-Dark Keypad
4. Stored Master Remote (Removable) with RJ45, RJ12/11 and Female Jacks

# CableMaster 500

## Screen Icons

	DATA/LAN cable test mode
	VIDEO/Coax cable test mode
	VOICE cable test mode
	TONE mode
	Port Link-Blink mode
	Passed cable test
	Failed cable test
Open	There is a break in a wire between the ends
Mis-wire	The wires in a pair are not in the proper order
Short	The pairs are in contact with each other at a point in the cable
Rev	Wires are reversed
Split	A wire in one pair is switched with the wire of another pair
X-Over	Cross-over cable detected
ID no.	ID number for an attached remote
VOLTAGE!	Voltage higher than 60V has been detected
UTP/STP	End-to-End shielded detection
	Setup Menu
	Audible Beep
	Low Battery Indicator
	Select Up/Down Keypad Buttons
	OK Button
	Setup Button
	Tester Mode Button
	Test Button
	Power/Backlight & LED Flashlight Button

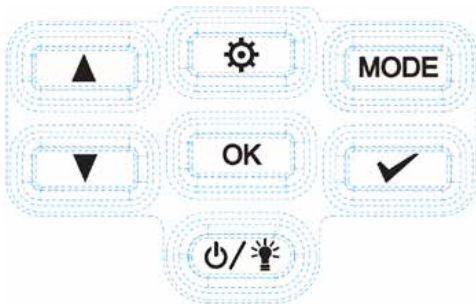
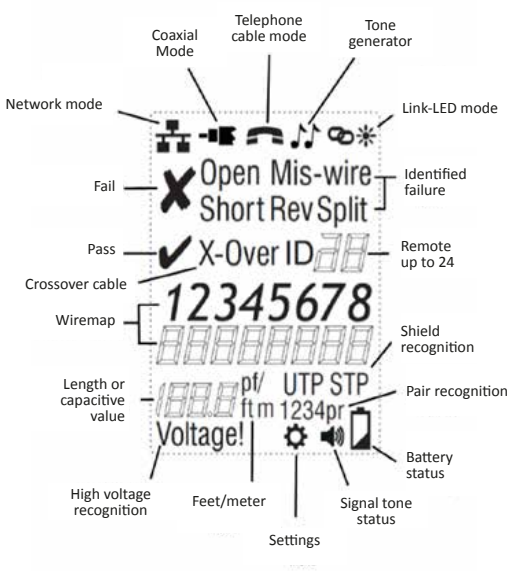

# CableMaster 500

## Test Results and Other Functions

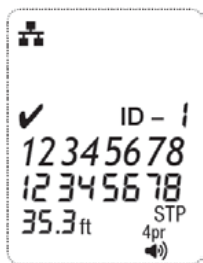

PASS, Data Cable,  
STP, Remote #1,  
35.3 ft

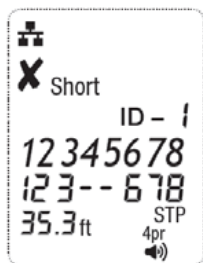

FAIL, Data Cable,  
STP, Short on 4/5,  
Remote #1, 35.3 ft

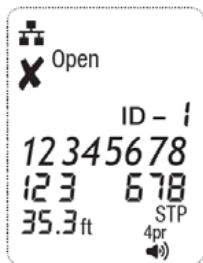

FAIL, Data Cable,  
STP, Open on 4/5,  
Remote #1, 35.3 ft

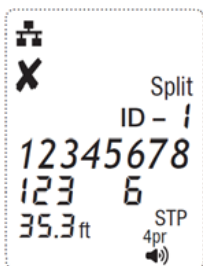

FAIL, Data Cable,  
STP, Split on 4/5 and  
7/8 (Splits always  
affect at least 2  
pairs), 35.3 ft

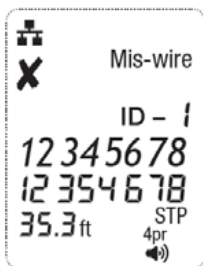

FAIL, Data Cable,  
STP, Mis-wire on  
4/5, Remote #1,  
35.3 ft



FAIL, Data Cable,  
UTP, Open on 1/2,  
3/6 and 7/8, Short  
on 4/5, remote ID  
not detected, 35.3 ft



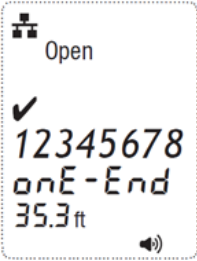

PASS, Data Cable,  
Single-ended test,  
shielding not tested,  
35.3 ft

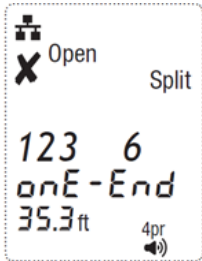

FAIL, Data Cable,  
Single-ended test,  
Split on 4/5 and 7/8,  
shielding not tested,  
35.3 ft

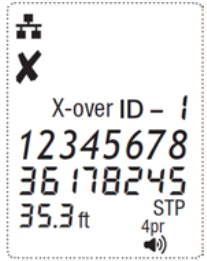

FAIL, Data Cable, STP,  
Cross-over detected,  
35.3 ft (Tester set in  
ANY Cable mode)

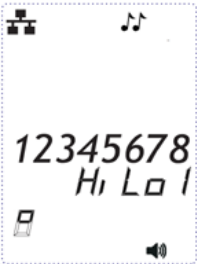

TONE mode, Hi Lo  
warble, Tone On



Port Link Blink  
Mode, Blink On



Data Cable, High  
Voltage detected!  
Disconnect  
immediately to  
prevent damage  
to the tester

# CableMaster 500

## Using the Tester

The corresponding connectors at the top end of the tester are labeled the same as their mode switches. An icon for the currently selected mode will appear or flash on the screen.

To turn the CableMaster 500 off when in one of the cable test modes, press and hold the power button until the tester powers off.

The top line of numbers (*Fig 1*) on the display represents the connector pins on the main unit. The second line of pin numbers represents the connector pin numbers of the remote, normally being the same as the top line for a one-to-one wired cable.



Figure 1 – Wire Map

If there is a mis-wire (*Fig 2*), the pin numbers on the second line will indicate the pin numbers detected and the “Fail” icon will appear.



Figure 2 – Mis-Wire

The associated pin numbers of a mis-wired pair will blink in the remote row. If no connection was detected for some of the pins, the first and second line of pin numbers will be blank in those pin locations. If a short is detected, the second line (*Fig 3*) will have a dash '-' in those positions along with “Short” appearing.

Note that this tester will not determine which end of a faulty cable is mis-wired, reversed, or split.

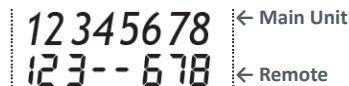

Figure 3 – Shorts

If a split pair (Fig 4) is detected, those pin positions on the first and second line will be flashing the pin numbers detected from the remote and the “Split” icon will be flashing. If there are multiple errors to display, there will appear a combination of the above error.

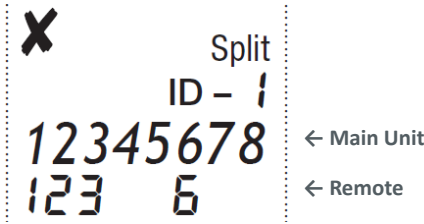

Figure 4 – Split Pairs

The ID icon (Fig 5) will have a number directly to the right of it, indicating the remote ID number.



Figure 5 – Remote ID Number

Whenever the “TEL” or “DATA” icons are on, a new test is in progress. In the coax mode, the “Open”, “Short” or “Pass” icon will appear to indicate the results of a test. If the cable passes, the “ID” icon will appear as well as a remote ID number on the bottom line of the display. The “Coax” icon appears when a test is in progress.

The tone generator operates in DATA, COAX and VOICE modes. In this mode, the conductors or pairs associated with one of the three connectors are displayed.

The specific mode (DATA, COAX, VOICE or TONE) is selected by pressing the MODE button. If the CableMaster 500 was off when the TONE button is pressed, the last cable test mode used will be selected and selected pairs are used.

# CableMaster 500

## Cable Testing

The top line (Fig 6) displays the cable type test mode, tone generation and link light modes.



Figure 6 – Tester Modes

Select the test mode by pressing the MODE button until the correct icon is displayed.

Press OK/Test keys to start the test.

Data Cable Test



Coax Cable Test



Phone Cable Test



## Voice/Data Cables

Up/Down keys select pins used for length, OK/Test keys resume testing (automatically returns after 5 seconds of no activity). The “LEN Auto” setting measures the first pin pair it can find without a short or other detected problem.

The CableMaster 500 assumes the 8-position jack on the main unit and the remote will be used for connecting the tester to the cable run to be tested. The TIA/EIA 568A/B standard is used to define the pairs. Connector pins 1-2, 3-6, 4-5 and 7-8 are the pairs defined by this standard. The A and B standards are the same except for color-coding and are indistinguishable from each other by electrical testing.

**Specific Pair Length** – The CableMaster 500 can be used to measure the length of specific pairs for data and telephone twisted pair cables. While in DATA or VOICE cable test mode, pressing the up/down arrow will change the pair selection to the following options:

### Data Cables

AUTO-LENGTH measures the length of the first pin pair that doesn't have a fault (e.g. not shorted). In most cases, for a data cable that is good, pair 1-2 will be tested.

1-2, 3-6, 4-5, 7-8

### Telephone Cables

AUTO-LENGTH measures the length of the first pin pair that doesn't have a fault (e.g. not shorted). In most cases, for a phone cable that is good, pair 3-4 will be tested.

3-4, 2-5, 1-6

## Remotes

There are four types of remotes that can be used with the tester:

- **Master Remote:** This remote is stored in the lower half of the tester. It is used for both cable verification (fault) testing and for mapping. The CableMaster 500 master remote has three jacks built into it for convenient testing: RJ45, RJ12/RJ11 on one side and an F-female on the other. The Master Remote has a unique ID #1 as its identifier when used for mapping.
- **Smart Remotes:** These are test and ID twisted pair remotes. With an RJ45 jack on one end and an RJ12/RJ11 jack on the other end, they are used for fault testing Data or Telephone cables. They also have unique ID numbers and are used to map the end location of the cable. Test remote IDs are shown in the tester display with a hyphen (e.g. "ID - 4").
- **Coax Test and ID Remotes:** Coax remotes are used when testing for shorts and opens in a coax cable. Each coax remote also has a unique ID number for mapping cable ends. Do not use a remote when testing for the open length of cables.

Pressing the O/ID button starts the ID test mode on the CableMaster 500. ID/MAP up to 24 locations at one time with numbered custom ID remotes.

# CableMaster 500

- **LAN ID-only Remotes:** These remotes have a unique ID number and are only used to map the location of the jack that the data cable is plugged into.

**Note:** LAN ID only remotes are not used for cable testing.

## Interpreting Tests Results

- **Pass/Special Cables:** “Pass” will appear if the cable is a properly wired 4-pair T568A/B data cable, a 3-pair one-to-one wired voice cable or a video cable with no faults. Uplink cables, also known as crossover or T568A-to-T568B cables, are commonly used to connect two computers or two hub switches directly together. Crossover cables are detected and displayed as “X-Over”.

In addition, “X-Over” is displayed, if a properly wired cross-over (uplink) cable is recognized. “Rev” appears if the cable is a properly wired reverse-pinned voice cable. The wire map will show actual pin connections if all 8 pins are correctly wired with the 1-2 and 3-6 pairs crossed.

- **Cable Faults:** The “Fail” icon will only appear if the cable is not wired to one of the cabling standards. An open or short error takes precedence over other faults.
- **Shielding (Ground) Detection:** “STP” appears when a shielded data cable is properly connected at both ends. “UTP” appears if there is no end-to-end continuity in the shielding detected.
- **Short:** It will be flashing if there is a short to a wire in the cable along with that pin number and the “Short” indicator.
- **Tester-End Wire Map:** The top line displays the pins on the tester end in order. These pins are mapped to the pins on the remote-end shown directly below them on the LCD.
- **Remote-End Wire Map:** The bottom line displays the corresponding pin on the remote-end. Dash lines on the remote line indicate short pins. No pin numbers displayed on the remote line are open pairs.

- **Remote Location ID:** In the ID mode, the “ID” icon will be displayed with the number of the remote ID. If a remote is in place and a fault in the cable is detected, an error message of “Open” or “Short” is displayed.
- **Single-ended Testing:** If a remote is not used as in a “one-end” test, only shorts and splits will be displayed if detected.
- **Voltage Detected Warning:** If voltage is detected on any of the tester connectors, the “Voltage!” icon appears. For accurate testing results, unplug the cable from a switch or router.

## Video (Coax) Cables

Tests for shorts, opens and ID's up to 20 unique remotes (P/N TRK120) on the F-connector jack. Connect one end of the coax cable to the F-connector jack on the top of the tester. Connect the other end of the coax cable to the F-connector jack on the master remote and press the test key to scan for the remote ID. To measure the length of a cable, DO NOT use a remote.

## Voice (POTS) Cables

The phone test behaves similarly to the data cable test. The CableMaster 500 is designed to test twisted pair phone cables; using it to test flat cable may result in false “split” results. The CableMaster 500 assumes the 6-position jack on the main unit and the remote will be used for connecting the tester to the cable run to be tested.

This mode uses the 3-pair USOC standard to define the pairs. Connector pins 1-6, 2-5 and 3-4 are the pairs defined by this standard.

The tester will display the “Pass” icon when all 6 pins are correctly wired in a one-to-one order. If all 6 pins are correctly wired in the reverse order, the “Pass” icon appears along with a flashing “Rev” icon. Standard telephone cables used between a phone set and a wall jack are usually reverse-pinned.

After turning on the telephone cable test mode, subsequent presses of the test button will initialize a new test cycle. This is useful to immediately begin a new test when attaching a new cable to the CableMaster 500.

# CableMaster 500

## Set Up Menu

(see Figure 7 – Set Up Menu Map)

There are two paths for changing the settings:

A. The “General Setup Menu” changes the settings for:

- Feet or meters when measuring cable length
- Setting the capacitance value for a specific cable
- Turning the audible beep on/off

B. The “Set Pass Criteria Menu” allows you to set the PASS parameters for a specific configuration including:

- Shielded or unshielded detection
- Single or multiple pairs
- Cross-over (X-Over) for data cables
- Reverse-wired phones cables

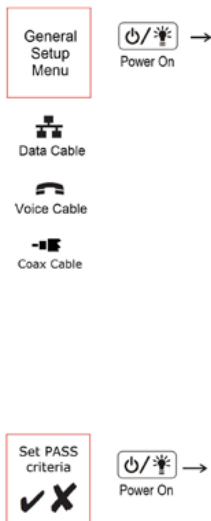

In the “ANY” Cable Configuration setting, the CableMaster 500 will test the cable for a standard TIA568 configuration and display UTP if no continuous shield is detected or STP if a continuous shield is detected. It is likely that you will use this setting for most if not all your testing, but the custom settings will allow you to test specific configurations.

**NOTE:** To access the **SET PASS CRITERIA MENU**, you must press and hold down the **SETTINGS** button for more than 2 seconds.

When editing a setting, press the Setup button to return to Setup loop without saving. Pressing the OK button saves the setting and returns to the Setup loop menu. Pressing the Test key saves the current setting and returns to the testing mode. Pressing the Mode button discards any changes to the current setting and returns to the Mode select loop menu.



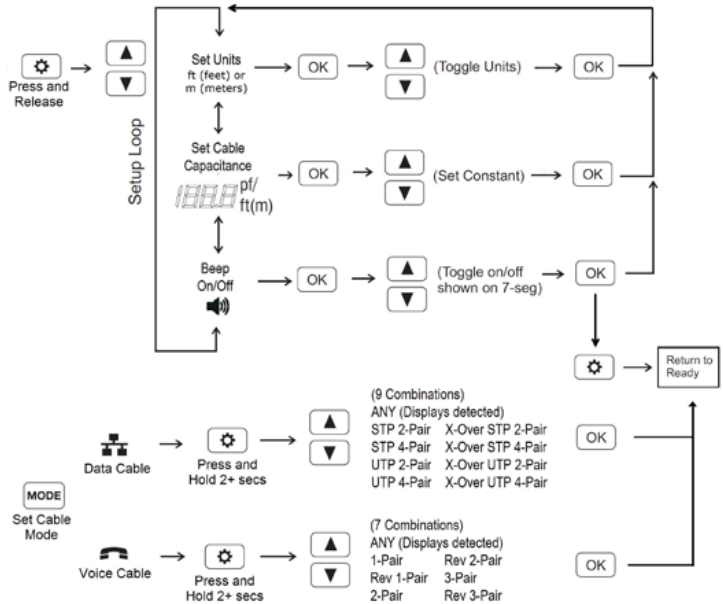

Figure 7 – Set Up Menu Map

# CableMaster 500

## Setting the Cable Capacitance

The capacitive value is used in measuring the length of a cable. The values are preset in the tester, but a custom value can be set for more accurate measurements. To calibrate the value for a specific cable, use a known length of cable, 15 feet (4.5 meters) or more is recommended. Test the cable and adjust the capacitive value until it shows the actual length of the cable. Press "OK" to save the value. The tester is now set for the same spool of cable that you used to calibrate the capacitance for.

With AUTO-LENGTH selected, set the capacitance value. The first pair that does not have a fault will be the pin pair being displayed. For example, if there is a short on pair 1-2, pair 3-6 are measured in AUTO-LENGTH and you'll see 3-6 displayed when you set the capacitance value.

## Pass/Fail Settings

When the cable does not match the pass criteria (e.g. UTP instead of an expected STP), the detected condition is displayed and the expected one blinks (e.g. UTP icon on, STP icon blinking). X-Over does not have an alternate icon so it blinks if there is a mismatch between expected and actual.

## Single-Ended Testing

If no test remote or mapping ID is found, a single-ended test is performed on the open cable. A single-ended test first measures the length of all 8 wires. If all wires are greater than 4 feet, a split-pair test is performed. Also, the wire lengths are compared to test whether they are all within 10% of each other. If these conditions are met, the Check icon is activated and "ONE-END" is displayed.

Splits are identified by flashing the corresponding numeric icons (Split and X-Over icons activated). If no splits are found, but some wires are less than 10% of the longest wire, "diFF LEN" is displayed and the corresponding numeric icons are flashed.

### For single-ended testing:

- A 1-pair cable is declared if the 3-4 pairs are at least 3 feet long and the 2-5 and 1-6 pairs are less than 2 feet.
- A 2-pair cable is declared if the 3-4 and 2-5 pairs are at least 3 feet long and the 1-6 pair is less than 2 feet.
- A 3-pair cable is declared ID if all the pairs are at least 3 feet long. If an unconventional configuration of wire pairs is detected (e.g. 1-6 and 2-5), the expected pair icon blinks and the Mis-wire icon is activated. Current default pass criteria are 2-pair, reversed.
- A 4-pair cable is declared if all the pairs are at least 3 feet long. If neither criterion is met, the number of pairs is left unknown.

## Port Link Light

The Port Link Light function allows the tester to “blink” the port on a switch or router that a data cable is inserted in. In this mode, the Ethernet LED in the port will blink in the same frequency as the tester.

Connect the cable from the switch to the tester and press the MODE button until the Link Light icon and “Linc” is displayed on the screen, then press “OK”.

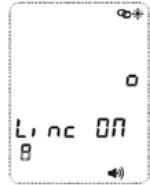

Figure 8 – Port Link Light

If “Linc OFF” is displayed, press the test button (check mark), to turn it on. To turn the Link Light off, press the test button until “Linc OFF”.

## Continuous Loop Testing

While in a cable test mode, hold Test key for 2+ seconds to toggle looping on/off.

## Backlight and Built-in LED Flashlight

By default, the LCD backlight is turned off when the tester is powered on.

- To turn the LCD backlight on, with the tester powered on, press the power button again.
- To turn the backlight off, press and release the power button.

Note that the backlight and built-in LED are synchronized to both be turned on or off at the same time.

# CableMaster 500

## Tone Mode

The Tone Mode generates audio tones on all pairs, a selected pair or a selected pin. These tones can be heard by using an inductive tone tracer. The signal generated on a pair has the signal on one pin and the complement of the signal on the other pin of the pair, yielding a nominal 10 Volts peak-to-peak across the pair.

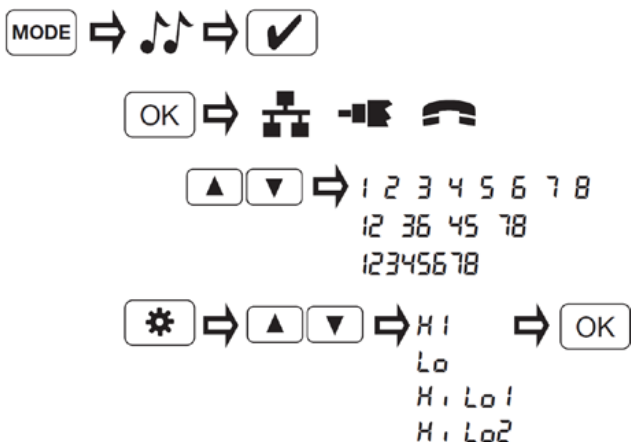

Pressing the “OK” key toggles through cable types (Data, Video, Phone).

Pressing the “Test” key toggles Tone on and off.

Pressing “Up/Down” keys select pins used for Tone.

To change the tone, press the “Setup” key, then press the “Up/Down” keys to change the cadence. Press the “OK” key to save the cadence selected. The tone pattern options are Hi, Lo, HiLo1 and HiLo2. The HiLo options are dual or warble tones of differing pattern duration.

## Specifications

Item	Description
Display	Large 2.75" Backlit Monochrome LCD
Dimensions	6.8" x 3.2" x 1.4" (17.3 x 8.1 x 3.5 cm)
Weight	10.8 oz. (305 grams) with battery and remote
Operating Temperature	0°C/32°F to 50°C/122°F
Storage Temperature	-20°C/-4°F to 60°C/140°F
Humidity	10% to 90%, non-condensing
Maximum Voltage between any two connector pins without damage	RJ12/RJ45/F: 50V DC or AC
Battery Life	9V alkaline battery typical – Standby: 4 years – Active: 425 hours
Cable Types	Shielded or Unshielded; CAT7, CAT6A, CAT5E, CAT5, CAT4, CAT3, Coax
Maximum Cable Length Testing	0 to 1,000 feet (305 meters)
Minimum Cable Length for Split Pair Detection	1.5 feet (0.5 meters)
Maximum Coax Cable Length	Varies depending on cable resistance
Low Battery	Icon flashes when battery voltage falls below 6V
Measurement Technology	Capacitance testing
Length Accuracy Without Length Constant Accuracy	± 3% plus + 1 ft (30 cm)
Default Length Constant (Restored with power on reset)	Voice (Twisted pair): 17.4 pF/ft Video (Coax): 16.5 pF/ft Data (Twisted pair): 15 pF/ft

**Specifications are subject to change without notice.**

# CableMaster 500

## WARRANTY

Softing IT Networks GmbH warrants that the product shall be free from defects in parts or workmanship for a period of 12 months from the date of purchase if used in accordance with Softing IT Networks GmbH operating specifications.

THIS IS THE ONLY WARRANTY MADE BY Softing IT Networks GmbH AND IS EXPRESSLY MADE IN LIEU OF ALL OTHER WARRANTIES EXPRESSED OR IMPLIED, INCLUDING BUT NOT LIMITED TO ANY IMPLIED WARRANTIES OF MERCHANTABILITY OR FITNESS FOR ANY PARTICULAR PURPOSE.

Should any parts or workmanship prove defective, Softing IT Networks GmbH will repair or replace at Softing IT Networks' option, at no cost to the Buyer except for shipping costs from the Buyer's location to Softing IT Networks. This is Buyer's SOLE AND EXCLUSIVE REMEDY under this Agreement. This warranty does not apply to products which have been subject to neglect, accident or improper use, or to units which have been altered or repaired by other than an authorized repair facility.

### **For European-Customers:**

**Return of Equipment:** To return a product to Softing IT Networks GmbH, first obtain a Return Authorization number from our Customer Service by calling +49-89-45 656 660. The RMA number must be clearly marked on the shipping label.

To: Softing IT Networks GmbH  
Richard-Reitzner-Allee 6  
85540 Haar  
Germany  
RMA-Nr. XXXXXX

### **For North American-Customers:**

**Return of Equipment:** To return a product to Softing inc, first obtain a Return Authorization number from our Customer Service by calling +1.865.251.5252. The RMA number must be clearly marked on the shipping label.

To: Softing Inc.  
7209 Chapman Highway  
Knoxville, TN 37920  
USA  
RMA-Nr. XXXXXX

### **For ASIA/PACIFIC-Customers:**

**Return of Equipment:** To return a product to Softing Singapore PTE LTD, first obtain a Return Authorization number from our Customer Service by calling +65-6569-6019. The RA number must be clearly marked on the shipping label.

To: Softing Singapore Pte. Ltd.  
3 Science Park Drive  
#03-09 The Franklin  
Singapore Science Park 1  
Singapore 118223  
RMA-Nr. XXXXXX

©2020 Softing IT Networks. In line with our policy of continuous improvement and feature enhancement, product specifications are subject to change without notice. All rights reserved. Softing and the Softing Logo are trademarks or registered trademarks of Softing AG. All other trademarks, registered or unregistered, are sole property of their respective owners.

## NOTES

---

---

---

---

---

---

---

---

---

---

---

---

---

---

---

---

---

---

---

---

---

# CableMaster 500

## HEADQUARTERS

Softing IT Networks GmbH

Richard-Reitzner-Allee 6

85540 Haar

Germany



+49 89 45 656 660



[info.itnetworks@softing.com](mailto:info.itnetworks@softing.com)

Find your local distributor:

[itnetworks.softing.com/contact](https://itnetworks.softing.com/contact)